



GUIDE FOR USING THE DISHWASHER AND THE WASHING PROGRAMS

1. Description of the controls	2
2. Operating instructions	15
3. Cleaning and maintenance	30
4. Troubleshooting	34

Thank you for choosing one of our products.

You are advised to read this manual carefully; it contains all the information you need to use your dishwasher safely, correctly and in the most satisfactory manner.

Following the cleaning instructions provided here will keep your dishwasher's performance at peak levels in the long term.



***USER INSTRUCTIONS:** these consist of recommendations for using the appliance, a description of its controls and of the correct cleaning and maintenance procedures.*



1. Description of the controls

1.1 Front panel

All the dishwasher controls are grouped on the front panel.

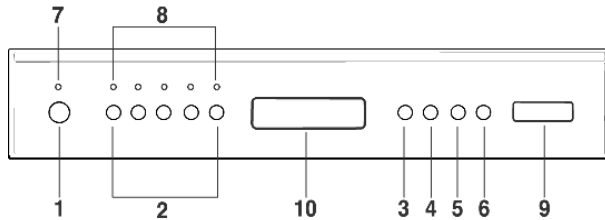

1	ON/OFF BUTTON
2	SELECTION PROGRAM BUTTONS (P1...P5)
3	OPTION SELECTION BUTTON
4	CONFIRM OPTIONS BUTTON
5	DELAY PROGRAM BUTTON
6	START/PAUSE BUTTON
7	POWER ON LIGHT
8	PROGRAMS INDICATOR LIGHTS
9	INFORMATION DISPLAY
10	RECESSED DOOR HANDLE

N.B.: symbols and styling are guideline and may vary depending on the model or version of the dishwasher purchased.



1.2 Information display

The dishwasher is equipped with a practical **DISPLAY** which provides information on the programmed dishwasher functions.

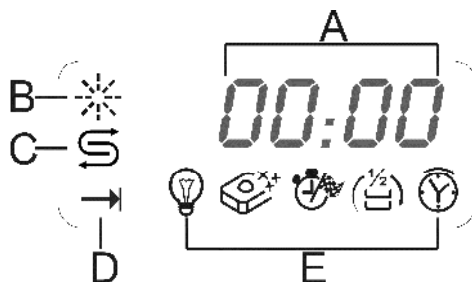

A	4-FIGURE DISPLAY
B	RINSE AID WARNING LIGHT
C	SALT WARNING LIGHT
D	START/PAUSE BUTTON
E	OPTIONS LIGHT

PROGRAMS TABLE

The manual contains the programs table for several models. To find the table for your dishwasher, compare the program symbols at the top of the table with those on your control panel.







PROGRAMS TABLE



Eco



PROGRAMME NUMBER & SYMBOL	LOAD CROCKERY AND CUTLERY	PROGRAM PROGRESS	DURATION	CONSUMPTION	
			MINUTES (1)	WATER LITRES	POWER KWh (1)
1 SOAK 	Pans and dishes awaiting completion of the load	Cold prewash	15	3,5	0,02
2 GLASS 	Glass, china and mixed dishes with light dirt.	Wash at 45°C Cold rinse Rinse at 70°C Dry	65	9,5	1,10
3 ECO (*) Eco EN 50242	Dishes with normal dirt, even with dried-on residues	Wash at 45°C Cold rinse Rinse at 55°C Dry	**	**	**
4 NORMAL  IEC/DIN***	Dishes with normal dirt, even with dried-on residues	Cold prewash Wash at 65°C Cold rinse Rinse at 70°C Dry	105	13,5	1,35
5 ULTRA CLEAN  ****	Very dirty pans and dishes, even with dried-on residues.	Hot prewash Wash at 70°C Cold rinse (2) Rinse at 70°C Dry	160	15,5	1,70

The **ULTRA CLEAN** program terminate with an extra anti-bacteria rinse that ensures a further reduction in the bacteria level. If the temperature falls during this stage of the program (e.g. because the door is opened or due to a power blackout), the **program lights** flash to warn that the anti-bacteria effect is not guaranteed.





IMPORTANT: see “NOTES AND REFERENCES” table on the following pages.



If the dishwasher door is open or not properly closed, the washing cycle will not start.



QUICK TIME PROGRAMS (see relevant section for explanation of functioning modes)

PROGRAMME NUMBER E SYMBOL	LOAD CROCKERY AND CUTLERY	PROGRAM PROGRESS	DURATION	CONSUMPTION	
			MINUTI (1)	WATER LITRES	POWER KWh (1)
6 RAPID 27' 	Dishes with light dirt, washed immediately after use	Wash at 38°C Rinse at 50°C	27	6,5	0,70
7 ECO QUICK 	Dishes with normal dirt, washed immediately after use.	Cold prewash Wash at 60°C Cold rinse Rinse at 70°C	80	12,5	1,25
8 NORMAL QUICK 	Dishes with normal dirt, washed immediately after use	Cold prewash Wash at 70°C Cold rinse Rinse at 70°C	95	11	1,25
9 STRONG and FAST 	Mixed dishes with normal dirt without dried-on residues.	Wash at 65°C Cold rinse Rinse at 70°C	55	9,5	1,35

IMPORTANT: see “NOTES AND REFERENCES” table on the following pages.



If the dishwasher door is open or not properly closed, the washing cycle will not start.



NOTES AND REFERENCES

Only run the soak program with half loads.

Options **cannot** be used with the soak program.

The **ENERSAVE** option cannot be used with **soak**, **ultra clean**, or any programs **which do not include** the final drying stage.

*	Standard programme under EN 50242 . The ENERSAVE option must be enabled .
**	See information sheet provided
***	IEC/DIN reference programme. The ENERSAVE option must be enabled .
****	Reference program for laboratories: Detergent: 20g in the dispenser + 10g in the door or tablet. Configuration : see photo in "Using the baskets".
(1)	Program consumption and duration figures have been measured in accordance with the EN 50242 standard. Values may vary depending on intake water and room temperatures and the type and quantity of dishes loaded.
(2)	1 or 2 cold rinses depending on the model.

REFERENCES for the **ENERGY LABEL** supplied with the dishwasher:

- Annual energy consumption is based on **280 standard wash cycles** with cold water and consumption of low-energy operating modes. Actual consumption depends on the way in which the appliance is used.
- Water consumption is based on **280 standard wash cycles**. Actual consumption depends on the way in which the appliance is used.
- Information refers to the **EN 50242 STANDARD** programme (identified in the programmes table), which is the most effective in terms of combined energy and water consumption. The programme is recommended for dishes with a normal level of dirt.
- Drying efficiency class on a scale from "G" (minimum efficiency) to "A" (maximum efficiency).



1.3 Washing programs

The dishwasher is equipped with a control panel and an **INFORMATION DISPLAY** from which it is possible to carry out all the power switch-on, switch-off and programming operations.



Before starting a washing program make sure that:

- The water supply tap is **open**.
- The **correct amount of detergent** has been added to the **dispenser**.
- The baskets have been **correctly loaded**.
- The spray arms are able to **rotate freely** and without obstruction.
- The dishwasher door is **securely closed**.

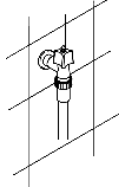

Warning:

during the initial phase of the washing program, the operation of sprayers is not perceived because they start rotating about 5 minutes after the start. This is the normal operation of the washing cycle.

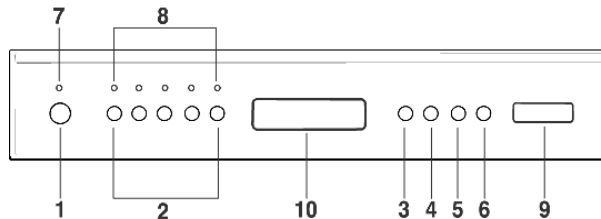

LIGHTING

Pressing the **ON/OFF** button will start the dishwasher and will lit up the dishwasher pilot light. After approximately **3 second** from this operation the **DISPLAY** will be turned on with a visualization that will depend upon the state of the dishwasher.

PROGRAMMING

All the programming operations are possible only with closed door. With open door, on the **DISPLAY** will appear - - : - -.



SELECTION PROGRAM



The program selection is possible through the relative buttons.



By pressing the relative button of desired program (see table) it will lid up the relative pilot light to confirm that the operation did occurred on the **DISPLAY** will appear a program duration forecasting (“h.mm”).



START PROGRAM

At this point, in order to start the machine, it is only enough to press the **START/PAUSE (6)** for some seconds until the symbol **START/PAUSE (D)** start to flash and confirmation “beep” is heard. From this moment the cycle duration on the **DISPLAY (9)** starts to decrease.

This phase, that updates itself during the cycle, is “indicative” since it is influenced by the washing conditions such as dishwasher type and quantity, entry temperature etc. For this reason it is normal to see the updating during a program (increment and decrease of minutes) specially in the passage from one phase to the other (for example, from washing to rinse).

END PROGRAM

The end of the program is indicated by a short signal acoustic and from the “End” visual notification on **DISPLAY**. By pressing one of the buttons, the “End” visual signal will vanish from the display and the dishwasher is ready to continue a new cycle.

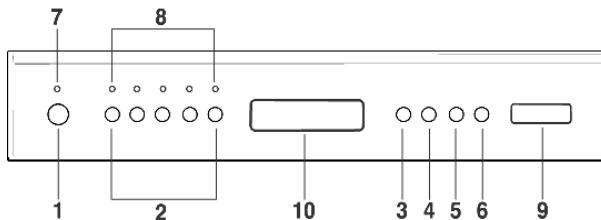

INTERRUPTING A PROGRAM

In order to interrupt a running program it is necessary:

- to press the **START/PAUSE**  for some seconds until when the symbol **START/PAUSE** remains lit on the display (confirmation beep). At this point, it is possible to start the cycle again, otherwise:
-



TO CHANGE A PROGRAM

To change the running program it is necessary:

- to interrupt the running program (see "INTERRUPTING A PROGRAM");
- select the new program;
- to press again the **START/PAUSE** button  to make start the new program.

STOPPING A PROGRAM

To cancel a program which is running:

- Interrupt the program (see "INTERRUPTING A PROGRAM")
- Press the **START/PAUSE** button  and hold it down; the display will show "P0" and the dishwasher will immediately switch to the end of the cycle and drain the tank (during this process, the "START/PAUSE" symbol will flash). When the drain procedure ends, the end of cycle "End" message appears on the display.

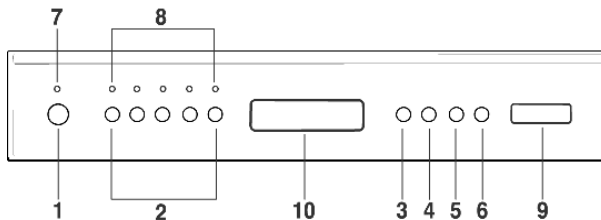



In case that the door is opened during the operation, to the next door closing it is going to be necessary to start the program as shown in paragraph "STARTING THE PROGRAM". The program will resume from the point in which it was interrupted.

In case that the tub temperature is higher than 50°C the program will start about 60 seconds later.



PROGRAM DELAY



The **PROGRAM DELAY**  button can be pressed to delay the start of the washing program by from **1 to 12/24** hours depending on the model. This option allows the dishwasher to be operated at the time of day of the user's choice. The first time the **PROGRAM DELAY**  button is pressed the option light comes on and 1:h appears on the **DISPLAY**. The button can then be pressed again, to set the delay required (2:h, 3:h, ... etc.). If no button is pressed for a few seconds, the **DISPLAY** shows the time left (time remaining) to the end of the selected program (e.g. 5:40, duration of the washing cycle + program delay). When the user confirms the program start (read the relative section) a prewash will be carried out, after which the **PROGRAM DELAY** set will begin, and the time remaining on the **DISPLAY** will gradually be counted down. At the end of the delay set, the option light goes out and the washing cycle starts.

N.B.: It is not possible to select the **PROGRAM DELAY** option once the cycle has begun.

Chosen the delay, proceed with the program start, press the button **START/PAUSE**  for some seconds until the **START/PAUSE** symbol start to flash.

The machine will perform a dish pre-washing, and when finish, the “delay program” will enter in function as it was first set.

In case you want to put to zero the “delay program” within the running program it is necessary:

- to press the **START/PAUSE**  button for some seconds until the **START/PAUSE (D)** symbol remain lid up on the display;
- to press the **DELAY PROGRAM**  more times until the reset of the delay program (**START/PAUSE** symbol shut off);
- to press the **START/PAUSE**  button to make start the program.

N.B.: It is not possible to select the “delay program” when the program have already began.



OPTIONS

The options are controlled by the **OPTION**

SELECTION button 



Press the button to access the procedure, confirmed by flashing of one of the **OPTIONS** lights (**E**).

N.B.: The **PROGRAM DELAY** light only comes on when the specific

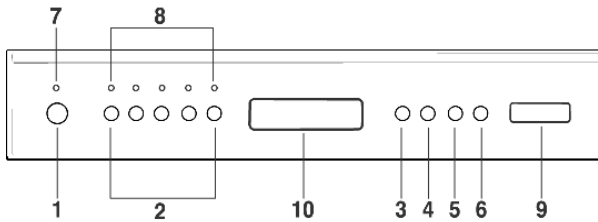
PROGRAM DELAY button  is pressed.



Press the **SELECT OPTIONS** button  again to display the next option.

To confirm an option, press the **CONFIRM OPTION** button  (the light stops flashing and remains on). This operation can be carried out for one or all of the options available. To deactivate an option which has already been confirmed, press the **OPTION SELECTION** button  until the **OPTION LIGHT** required flashes, and press the **CONFIRM OPTION** button . The light stops flashing and goes out.

All options **except "Flexi Tabs"** are **disabled** at the end of the wash cycle.

QUICK TIME PROGRAMS



QuickTime

Select this option together with any washing program (except the soak program) to **SHORTEN** the cycle by from a minimum of 10% to a maximum of 55%, depending on the cycle selected. To activate this

option, press the **QUICK OPTION** button  (light comes on) after selecting the program required. The option is automatically deactivated at the end of the program.



ENERSAVE



EnerSave

This option allows the further **reduction of energy** consumption, thanks to the assisted drying when the door opens at the end of the cycle. At the end of the wash, a device automatically releases the door, which slowly opens a few centimeters. This allows the best drying possible, even at low rinse temperature, permitting an important **energy saving**.

When the door is completely open, a brief sound signal indicates that the wash cycle has ended.

Enersave is automatically activated in all programs that **include** a final drying phase (see program table). It is possible to disable it before starting the program.



If this function is active, **never prevent the door from opening** by any means, clear the space necessary to allow the opening of the door. **Do not force the closure of the door** before the end of cycle signal, because this would damage the mechanism.



FlexiZone

SPREAD HALF LOAD

Suitable when there are not many dishes to be washed, it saves energy and reduces the program duration. Place dishes in both baskets then load the detergent dispenser than less than the normal amount for a full load.



Flexi Tabs

Flexi Tabs

Specifically for washing with combination detergents in **tablets**, which also contain **salt and rinse aid** (3in1) or other agents such as glass protector, steel rinse aids, etc. (4in1, 5in1...). When this option is selected, salt and rinse aid will not be dispensed even if the relative compartments contain them. If the containers are empty, the **lights** will remain **on**.

With short programs, because there is less time for them to dissolve, tablets may fail to wash effectively and undissolved residues may be left. Powder detergents are more suitable for these programs.

If the option is not provided, we recommend the use of conventional products (separate detergent, salt and rinse aid), because with conventional washing cycles, combined products might create problems such as a white deposit, poor drying results and residues left on dishes.

For further information, refer to the detergent pack.

IMPORTANT:

when no longer required, the option must be **deactivated** by pressing the relative **button** (the light goes out).



These products **are not suitable** for use with **excessively "hard"** water. If the hardness level set is higher than **H3**, when the option is activated the relative light flashes to indicate that the product is being used incorrectly; the dishwasher **will still work**, but washing results may be **poor**.

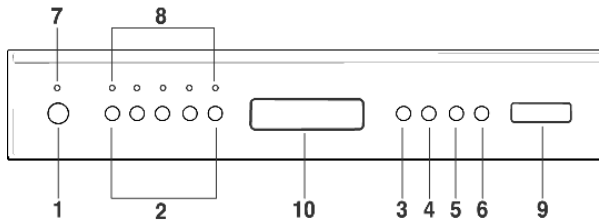



TO SAVE ON ENERGY! ... AND PROTECT THE ENVIRONMENT

- Always try to run the dishwasher **fully loaded**.
- Do not wash the dishes in running water.
- Use the washing program that is **most appropriate** for each type of load.
- Do not carry out any preliminary rinsing.
- If available, connect the dishwasher to a hot water supply up to 60°C.

TO CUT DOWN ON DETERGENT CONSUMPTION! ... AND PROTECT THE ENVIRONMENT

The phosphates contained in dishwasher detergents are harmful to the environment. To avoid using excessive amounts of detergent and to save on electricity, observe the following:

- **separate** the more delicate items from dishes that are more resistant to aggressive detergents and high temperatures;
- **do not pour** the detergent directly on the dishes.

ENERGY MANAGEMENT

After **5 minutes of waiting** (washing cycle completed, stopped or set but not started) the dishwasher switches to a **standby** state to reduce energy consumption.

In this state, the dishwasher indicator panel (lights or display depending on model) functions more slowly (**switch-on once every 5 seconds**).

REMOVING THE DISHES

At the end of the washing program, wait at least **20 minutes** before removing the dishes, to allow them to cool down. To prevent any water droplets on the upper basket from falling on the dishes in the lower basket, it is **advisable** to unload the lower basket first, and then the upper basket.



2. Operating instructions

Once the dishwasher has been correctly installed, prepare for use as follows:

- Adjust the water softening system;
- Add the regenerating salt;
- Add the rinse aid and detergent.

2.1 Using the water softening system



The amount of scale contained in the water (water hardness index) can cause whitish staining on the dry dishes, which tend to become dull over time. The dishwasher is equipped with an automatic softening system which uses a special regenerating salt to reduce the hardness of the water.

The dishwasher is factory set for water hardness level **3** (average hardness).

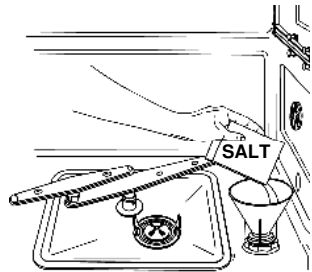

When using water of medium hardness, the regenerating salt container should be refilled after approximately **20 washing cycles**. The salt container can hold approximately **1.7 Kg** of salt in grains. The container is situated at the bottom of the dishwasher. After removing the lower basket, unscrew the salt container cap by turning it anticlockwise and pour in the salt using the funnel supplied with the dishwasher. Before replacing the cap, remove any salt residues from around the opening.



- *When using the dishwasher for the first time, in addition to the salt it is also necessary to add **one litre of water** to the container.*
- *Each time the salt container is refilled, make sure that **the cap is securely closed**. The mixture of water and detergent must never penetrate the salt container, as this would compromise the operation of the regeneration system. In the event of this occurring, the warranty will be invalidated.*
- ***Only** use regenerating salt specially formulated for domestic dishwashers. If using salt tablets, **do not fill the container completely**.*



- **Do not use table salt** as it contains insoluble substances which, over time, may damage the water softening system.
- When necessary, refill the regenerating salt container **before starting the washing program**. In this way, the excess saline solution will be immediately removed by the water; the prolonged presence of salt water inside the tank may lead to **corrosion**.





Be careful not to confuse the salt and detergent packages; adding detergent to the salt container will **damage** the water softening system.

ADDITIONAL FUNCTIONS (Customizing the consumer parameters) (available in all programs except the soak program)

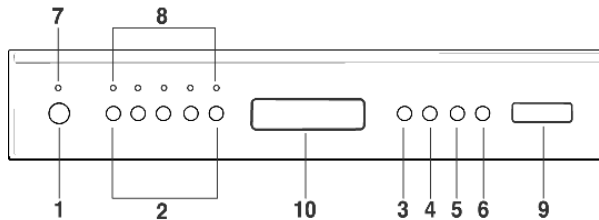
The electronic control system allows personalizing the machine use directly through a programming procedure not directly accessible that allows: regulate water hardness level.



To access the programming environment, the **appliance must be turned on** with the **door open**. Then proceed as follows:

- press the **PROGRAM DELAY** button  until the **H** symbol appears on the display, followed by the number currently set (e.g. **H3**)
- press the **PROGRAM DELAY**  button the number of times needed to select the right setting level for the hardness of the water (**H0, H1, H2, H3, H4, H5, H6**);

N.B.: after few seconds the appliance exits the parameter setting menu automatically.



WATER HARDNESS TABLE

WATER HARDNESS		SETTING
German degrees (°dH)	French Degrees (°dF)	
0 - 6	0 - 11	H 0 NO SALT
7 - 10	12 - 18	H 1
11 - 15	19 - 27	H 2
16 - 21	28 - 37	H 3
22 - 28	38 - 50	H 4
29 - 35	51 - 62	H 5
36 - 50	63 - 90	H6

Contact your local water board for information on the hardness of your water supply.

After adjustment or display of the current setting, simply do not touch the button for a few seconds; the dishwasher will automatically return to standard mode, quitting the adjustment mode.

2.2 Using the rinse aid and detergent dispensers

The detergent and rinse aid dispensers are situated on the inner part of the door: the **detergent dispenser** is on the left, and the **rinse aid dispenser** is on the right.

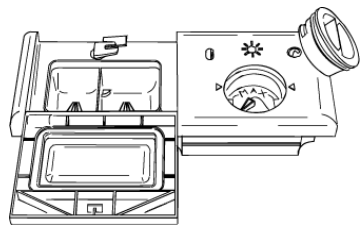

With the exception of the **SOAK** program, before every washing cycle it is necessary to add the required amount of detergent to the **detergent dispenser**. The rinse aid, on the other hand, should only be added as required.



ADDING THE RINSE AID

The rinse aid helps the dishes dry faster and prevents the formation of scale deposits and staining; it is automatically added to the water during the final rinse cycle, from the container situated on the inner side of the door.

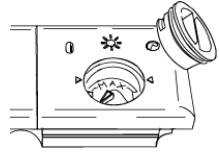

To add rinse aid:

- Open the door.
- Rotate the container cap anticlockwise by $\frac{1}{4}$ of a turn and remove it.
- Add the rinse aid until the container is full (approximately 140 cc). The optical level indicator on the side of the cap should be completely obscured. Refill the rinse aid when the optical level indicator becomes clear again, or when the rinse aid warning light illuminates.
- Replace the cover and turn it in a clockwise direction.
- Use a cloth to remove any spillage of rinse aid which might lead to the formation of excess foam.

ADJUSTING THE RINSE AID DISPENSER SETTING

The dishwasher is factory set for medium water hardness. However it is possible to change the setting by turning the dispenser's selector to the desired position: the amount of rinse aid dispensed is proportional to the selector position.

- To adjust the rinse aid setting, rotate the dispenser cap through a quarter turn in an anticlockwise direction and remove it.
- Then use a screwdriver to rotate the rinse aid selector to the desired position.
- Replace the cap, turning it clockwise.



- *The amount of rinse aid must be **increased** if the washed dishes appear dull or feature circular stains.*
- *If, on the other hand, the dishes are sticky or have white streaks, it is necessary to **reduce** the rinse aid setting.*



ADDING THE DETERGENT

To open the detergent dispenser cap, lightly press the button **P**. Add the detergent and close the cap carefully.

During the washing cycle, the dispenser will be opened automatically.

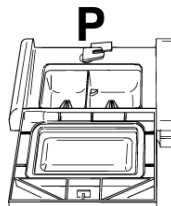
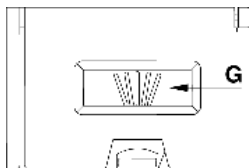
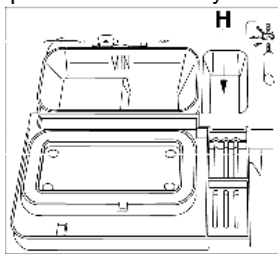

- When a program with hot prewash is selected (see program table), extra detergent must be placed in the cavity **G/H** (depending on models).
- Use **only** detergents specially formulated for dishwashers. For optimal washing results it is important to use a good quality detergent.
- The detergent packs must be sealed and stored in a dry place to prevent the formation of lumps which may negatively affect washing results. Once opened the detergent packs should not be kept for too long, otherwise the detergent loses its effectiveness.
- Do not use detergents formulated for washing dishes by hand, because they produce a great deal of foam and may negatively affect the operation of the dishwasher.
- Add the correct amount of detergent. An insufficient amount of detergent will result in a partial removal of dirt from the dishes, whereas an excessive amount is wasteful and does not improve the washing results.
- The market offers liquid and powder detergents with differing chemical compositions, which may contain **phosphates**, or be phosphate-free but contain **natural enzymes**.
 - Detergents containing **phosphates** are more effective against grease and starch at **temperatures above 60°C**.
 - **Enzyme** detergents, on the other hand, are also effective at lower temperatures (**from 40 to 55°C**) and are more easily biodegradable. With enzyme detergents it is possible to obtain at low temperatures comparable results to those which can only be achieved at **65°C** using traditional detergents.

For the safeguarding of the environment we recommend the use of **phosphate- and chlorine free** detergents.



The introduction of detergent into the rinse aid dispenser, even in liquid form, will damage the dishwasher.

2.3 General warnings and recommendations



Before using the dishwasher for the first time, it is advisable to read the following recommendations concerning dish types to be washed and their loading.

There are generally no constraints on the washing of domestic dishes, but in certain cases it is necessary to take their characteristics into account.

Before loading the dishes into the baskets it is necessary to:

- *remove coarse food remains: e.g. bones, fish-bones, etc. which may clog the filter or damage the wash pump.*
- *soak any pots or pans with burnt-on food remains on the bottom to facilitate removal, then load them into the LOWER BASKET.*

There is no need to pre-wash the dishes under running water before loading them into the baskets since this only wastes water.

Correct loading of the dishes helps ensure optimal washing results.



WARNING!

- *Make sure that the dishes are securely in place so that they cannot tip over or obstruct the rotation of the spray arms during the washing cycle.*
- *Do not place very small objects in the baskets as these could fall and obstruct the spray arms or the wash pump.*
- *Containers such as cups, bowls, glasses and pots should always be loaded with the opening facing downwards and with any cavities at an angle, to allow the water to drain out.*
- *Do not stack dishes or place them in such a way that they cover one other.*
- *Do not place glasses too close together because they may knock against each other and break, or there might be staining at the point where they touch.*

MAKE SURE that the items being washed are dishwasher-safe.

Items which are not dishwasher-safe:

- **Wooden dishes, pots or pans:** these may be damaged by the high washing temperatures.
- **Handcrafted items:** these are rarely suitable for washing in a dishwasher. The relatively high water temperatures and the detergents used may damage them.
- **Plastic dishes:** heat resistant plastic dishes must be washed in the upper basket.
- **Dishes and objects in copper, tin, zinc or brass:** these tend to stain.
- **Aluminium dishes:** items made from anodised aluminium may lose their colour.
- **Silverware:** silver items may stain.
- **Glass and crystal:** in general, glass and crystal objects can be washed in the dishwasher. However, certain types of glass and crystal may become dull and lose their clearness after many washings. Therefore, for these items we recommend using the least aggressive program available.
- **Decorated items:** the decorated objects available on the market are generally able to withstand washing in the dishwasher, although the colours may fade after a great many washes. If in doubt as to the fastness of the colours, it is advisable to wash just a few items at a time for approximately one month.



2.4 Using the baskets

The dishwasher has a capacity of **13 place-settings**, including serving dishes.

LOWER BASKET

The lower basket receives the full force of the lower spray arm, and should therefore be used for the “toughest” items with a heavier degree of soiling.

All types and combinations of loads are permitted, provided that the dishes, pots and pans are arranged with all the soiled surfaces exposed to the water jets coming from the bottom.

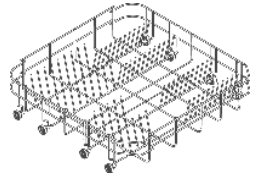

With fixed supports

To make the most of the space inside the basket when loading large items, certain models are equipped with tip-up supports for plates in 2 or 4 sections.

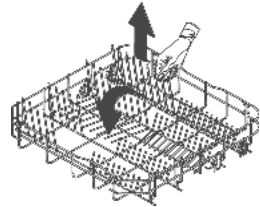

With tip-up supports

BOTTOM BASKET INSERTS

Some models are equipped with bottom basket inserts which improve the drying of dishes. The inserts are supplied in the accessories bag; to use them, simply fit them into place as shown.

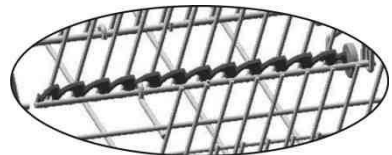
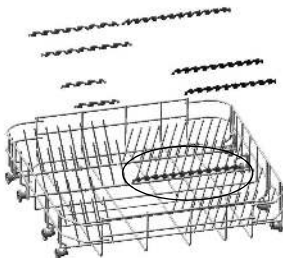



LOADING THE LOWER BASKET

Carefully load flat plates, soup plates, dessert and serving dishes, positioning them vertically. Pots, pans and their covers must be loaded upside down. When loading soup plates and dessert bowls, be sure to leave a gap between them.

Loading examples:

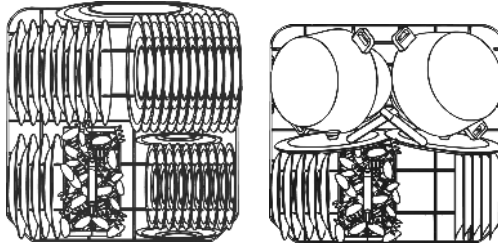

UPPER BASKET

It is recommended to load the upper basket with small- or medium-sized items such as glasses, small plates, tea or coffee cups, shallow bowls and light objects made from heat resistant plastic. If the upper basket is used in the lowermost position, it can also be loaded with serving dishes, provided they are only slightly soiled.

LOADING THE UPPER BASKET

Load plates facing forward; cups, bowls etc. must always be facing downwards. The left side of the basket can be loaded with cups and glasses on two levels. In the centre section, plates and saucers can be loaded vertically into the supports provided.

Loading examples:

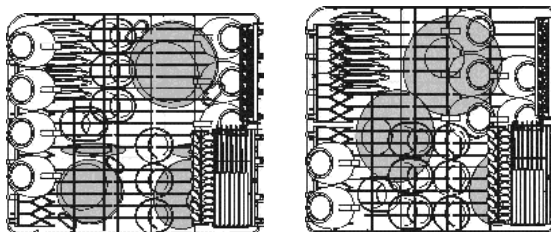



CUTLERY BASKET

The basket has **removable top grids** into which items of cutlery should be inserted to keep them properly spaced and allow water to pass between them effectively. The top grids and central lid are in the **bag of accessories**. The **central lid** functions as a **lid only**.

The top grids can be **detached** and **used separately**.

The cutlery should be arranged in an orderly manner inside the basket, with the handles pointing downwards. Take care during loading to avoid injury from the knife blades. The basket is suitable for all types of cutlery, except those long enough to interfere with the upper spray arm. Ladles, wooden spoons and cooking knives can be placed in the upper basket, **making sure that the knife blades do not protrude from the basket**.

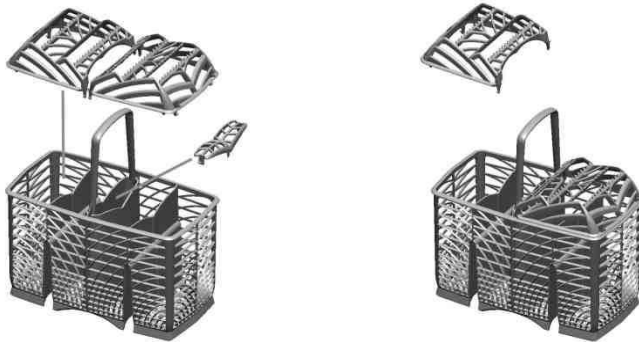

The cutlery basket slides across the dishwasher and can be **placed in any position** to allow optimal use of the space in the bottom basket.

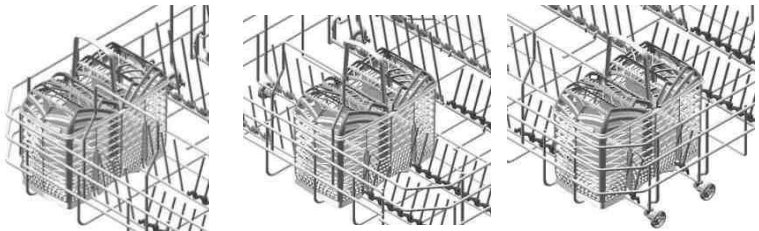



FLEXI DUO TOP RACK (on some models only)

This comprises **two independent** sliding, pull-out tray racks for easier loading/unloading of cutlery. Various loading systems and configurations are possible. For example, **tea cups** can be loaded with the **right-hand** rack set in the **low position**, while the left-hand rack or both can be removed to allow **large dishes** to be put in the **top basket**

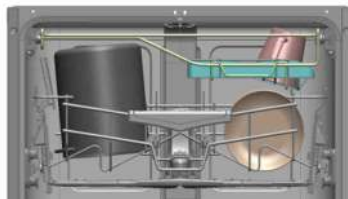
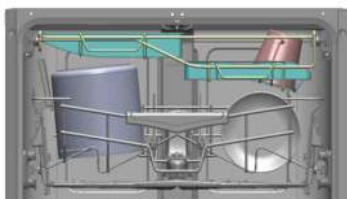
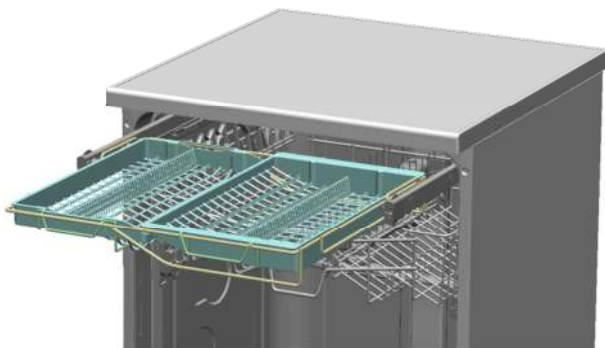



Examples of loading for intensive dirt:

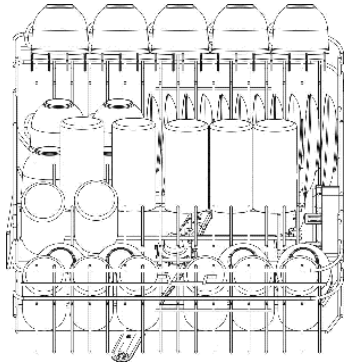
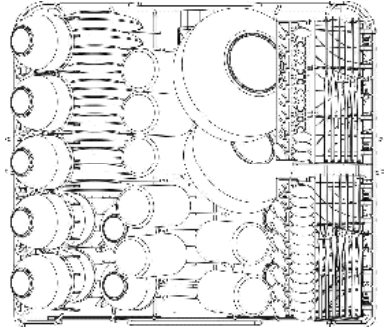
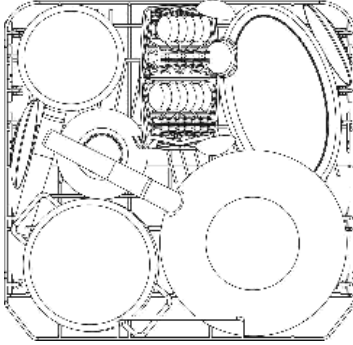



Examples of loading for intensive dirt: FLEXI DUO TOP RACK (on some models only)

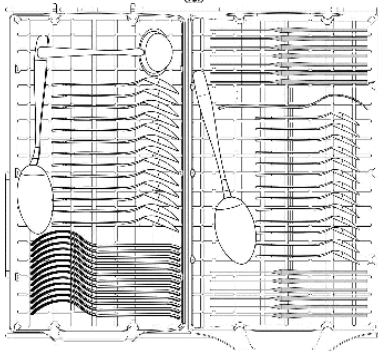
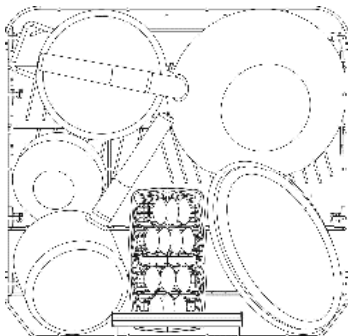
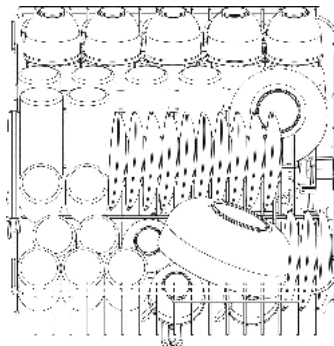
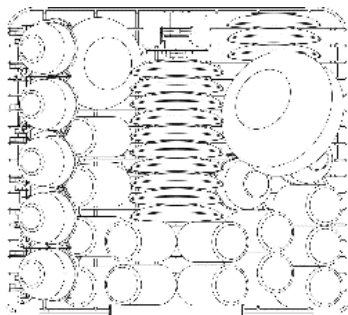



Depending on the models, the basket may be equipped with some or all of the following accessories:

- Supports for cups or long objects (ladles, spoons...), on the left; can be tipped to the vertical position when not in use.
- Long-stemmed glass holder, on the left; to use, simply lift and fix onto the hooks provided.
- Cutlery racks, on the right, designed for knives and teaspoons; for teaspoons, pull out the sliding support. The racks can be tipped to the vertical position when not in use.
- Fixed or movable racks in the middle. The movable supports can be fixed vertical, resting on the bottom of the basket when not in use, or set in the intermediate position, as required.

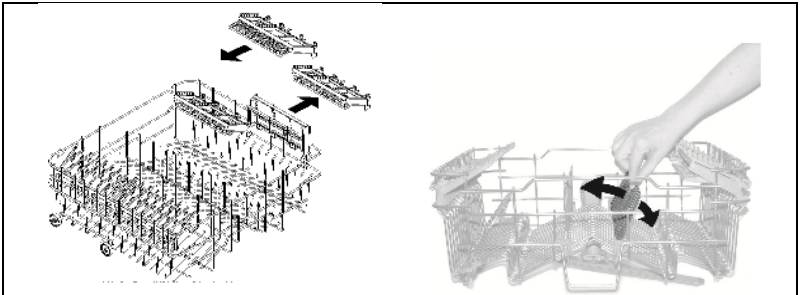
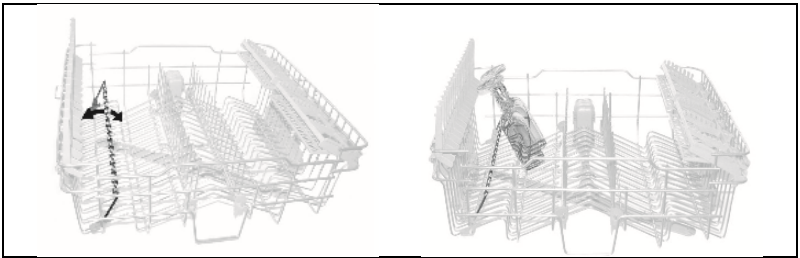



ADJUSTING THE UPPER BASKET

The height of the top basket can be adjusted to allow large dishes or pans to be placed in the bottom basket.

The adjustment procedure may be type **A** or **B**, depending on the dishwasher model purchased.

Version A: pull-out with adjustment in **two positions**.

- Pull out both the basket guides.
- Remove the stops, first releasing them as shown in the diagram.
- Pull out the basket.
- Fit the upper or lower pair of wheels into the guide, depending on the setting required;
- Return the stops to their original position.

The left hand and right hand sides of the basket **must always be set at the same height**.

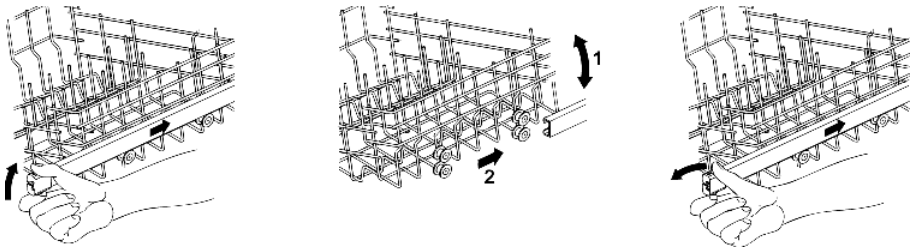

Version B: with adjustment in **three positions** on both sides.

The sides of the basket **must always be set at the same height**.

- Raise the basket by pulling on the top edge (1), to the first or second catch depending on the height required.
- To lower the basket, first release it by pulling the release lever (2).

Adjustment is also possible with the basket loaded, but in this case when lowering the basket it should be held steady with one hand to avoid knocking the dishes.

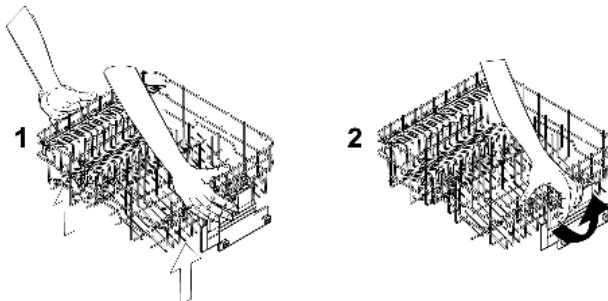



3. Cleaning and maintenance



Before carrying out any work, always unplug the appliance from the electrical supply or switch off the all-pole disconnection device.

3.1 General warnings and recommendations

Avoid the use of acidic or abrasive detergents.

Clean the outer surfaces and door-lining of the dishwasher regularly using a soft cloth moistened with water or with a normal detergent suitable for painted surfaces. Clean the door gaskets with a damp sponge. Periodically (once or twice a year) it is advisable to clean the tank and gaskets, using a soft cloth and water to remove any deposits.

CLEANING THE WATER INTAKE FILTER

The water intake filter **A** located at the outlet of the water supply tap needs to be cleaned periodically.

After having closed the water supply tap, unscrew the end of the water intake hose, remove the filter **A** and clean it delicately under running water. Reassemble filter **A** in its seat and carefully screw the water intake hose back into position.

CLEANING THE SPRAY ARMS

The spray arms can be easily removed for periodic cleaning of the nozzles, to prevent possible clogging. Wash them under running water and carefully replace them in their seats, **checking that their rotary movement is in no way impeded.**

- To remove the **upper** spray arm, unscrew locking ring **R**.
- To remove the **lower** spray arm, simply lift it up, pulling by the central part.
- To remove the **orbital** spray arm assembly, take hold of the longer arm and pull the orbital unit upward. Wash the arms under a jet of running water and return them carefully to their seat. **After reassembly, check that the spray arms turn freely.** Otherwise, check that they have been installed correctly.

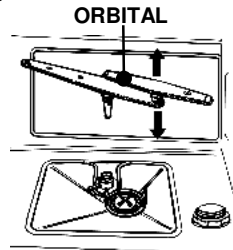
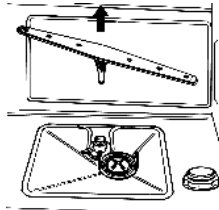
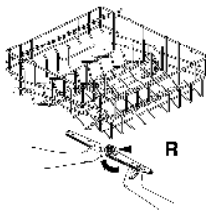



CLEANING THE FILTER UNIT

- It is advisable to periodically inspect the centre filter **C** and, if necessary, to clean it. To remove the filter, grip the tabs, turn them anticlockwise and lift upwards;
- push the centre filter **D** from the underside to remove it from the micro-filter;
- separate the two parts which make up the plastic filter by pressing the body of the filter in the zone shown by the arrows;
- remove the centre filter by lifting it upwards.

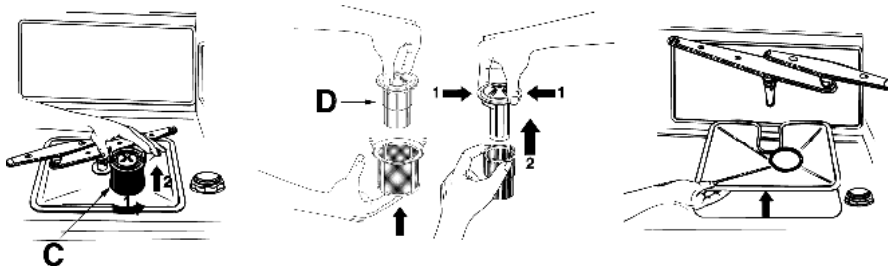

GENERAL WARNINGS AND RECOMMENDATIONS FOR CORRECT MAINTENANCE:

- The filters should be cleaned **under running water** using a stiff brush.
- **When removing the filter**, take care that there are no food residues on it. If any residues fall into the washing pit they might block hydraulic components, or foul the spray arm nozzles.
- It is essential to **thoroughly clean the filters** according to the above instructions: the dishwasher cannot function if the filters are clogged.
- **Carefully replace** the filters in their seats, to avoid damaging the wash pump.

PROLONGED DISUSE:

- Run the soak program twice in succession.
- **Unplug** the power cord from the socket.
- **Leave the door slightly open**, in order to prevent the formation of unpleasant odours inside the washing tank.
- **Fill the rinse aid dispenser.**
- **Shut off the water supply tap.**



BEFORE STARTING THE DISHWASHER AFTER PROLONGED DISUSE:

- *Check that there are no deposits of sludge or rust inside the water pipe: if there are, allow the water to run from the water supply tap for a few minutes.*
- **Plug the power cord** back into the socket.
- **Reconnect the water intake hose and open the tap again.**

TROUBLESHOOTING MINOR PROBLEMS

In some cases it is possible to remedy minor problems by referring to the following instructions:

If the program fails to start, check that:

- *the dishwasher is connected to the electrical power supply;*
- *there is no power failure;*
- *the water tap is open;*
- *the dishwasher door is properly closed.*

If water remains inside the dishwasher, check that:

- *the drain hose is not kinked;*
- *the drain siphon is not obstructed;*
- *the dishwasher filters are not clogged.*

If the dishes are not being cleaned properly, check that:

- *the correct amount of detergent has been added;*
- *there is regenerating salt inside the special container;*
- *the dishes are being loaded correctly;*
- *the selected program is suitable for the dish types and their degree of soiling;*
- *all the filters are clean and positioned correctly;*
- *the spray arm nozzles are not obstructed;*
- *there is no object obstructing the rotation of the spray arms.*



If the dishes fail to dry or remain dull, check that:

- there is rinse aid inside the special container;
- the rinse aid dispenser setting is correct;
- the detergent used is of good quality and has not lost its effectiveness (for example, through incorrect storage, with the box left open).

If the dishes show signs of streaking, staining, etc., check that:

- the rinse aid dispenser setting is not too high.

If there are visible traces of rust inside the tank:

- the tank is made of steel, and therefore any rust marks are due to external elements (fragments of rust from the water pipes, pots, cutlery, etc.). Special products are commercially available to remove such marks;
- check that the amount of detergent being used is correct. Certain detergents can be more corrosive than others.
- check that the cap of the salt container is securely closed, and that the water softening setting is correct.



If after following the above troubleshooting instructions the problem persists, call the nearest After-Sales Centre.

WARNING: any operations performed on the appliance by unauthorised persons are not covered by the warranty and shall be paid for by the user.



4. Troubleshooting

The dishwasher is equipped with a self-diagnostics system that is capable of detecting and signalling a number of possible faults.

TABLE OF FAULTS DETECTED BY THE SELF-DIAGNOSTICS SYSTEM

FAULT	DESCRIPTION
Er 01	The anti-flooding system (where present) has been tripped service.
Er 02	The water level limitation system has tripped.
Er 03	The appliance cannot heat the water.
Er 04	The temperature sensor is disconnected.
Er 05	The appliance cannot take in the water.
Er 06	The appliance cannot drain the water from the tank.
Er 07	The dishwasher cannot measure the precise water quantity that has been loaded.
Er 08	Problem on the water distribution system to the baskets.
Er 09	Water intake system malfunction.
Er 11	Wash motor pump does not work. Contact the after-sales service.

If an alarm occurs the appliance interrupts the program in progress and signals a fault.

- Alarms **E1**, **E2**, **E3**, **E4**, **E8** and **E9** interrupt the current program immediately.
- The **E5**, **E6** alarms interrupts the running program once the cause is resolved, it will bring back the execution of the program.
- The alarm **E7** is visualized at the end of the cycle that comes, however, brought to the end since the operation of the dishwasher is not harmed.

To "reset" an alarm is necessary:

- Open and close the door, or turn off and on the machine. At this point is possible to program the dishwasher again.



User instructions

EN



If the malfunction persists, contact your authorised Service Centre.

TECHNICAL DATA

Width	597 ÷ 599 mm
Depth measured flush with the outer edge of the control panel	Free standing: 600 mm Semi-integrated: 570 mm
Height (depending on models)	Free standing: from 850 mm to 870 mm from 890 mm to 910 mm Semi-integrated: from 820 mm to 890 mm from 860 mm to 930 mm
Capacity	13 Standard place settings
Water supply pressure	min. 0,05 - max. 0,9 MPa (min. 0.5 – max. 9 bar)
Electrical characteristics	See rating plate